

● Vertical Loading Mold Change System

For Molds with Different Width

※ This drawing shows the system circuit reference for GBE clamp.

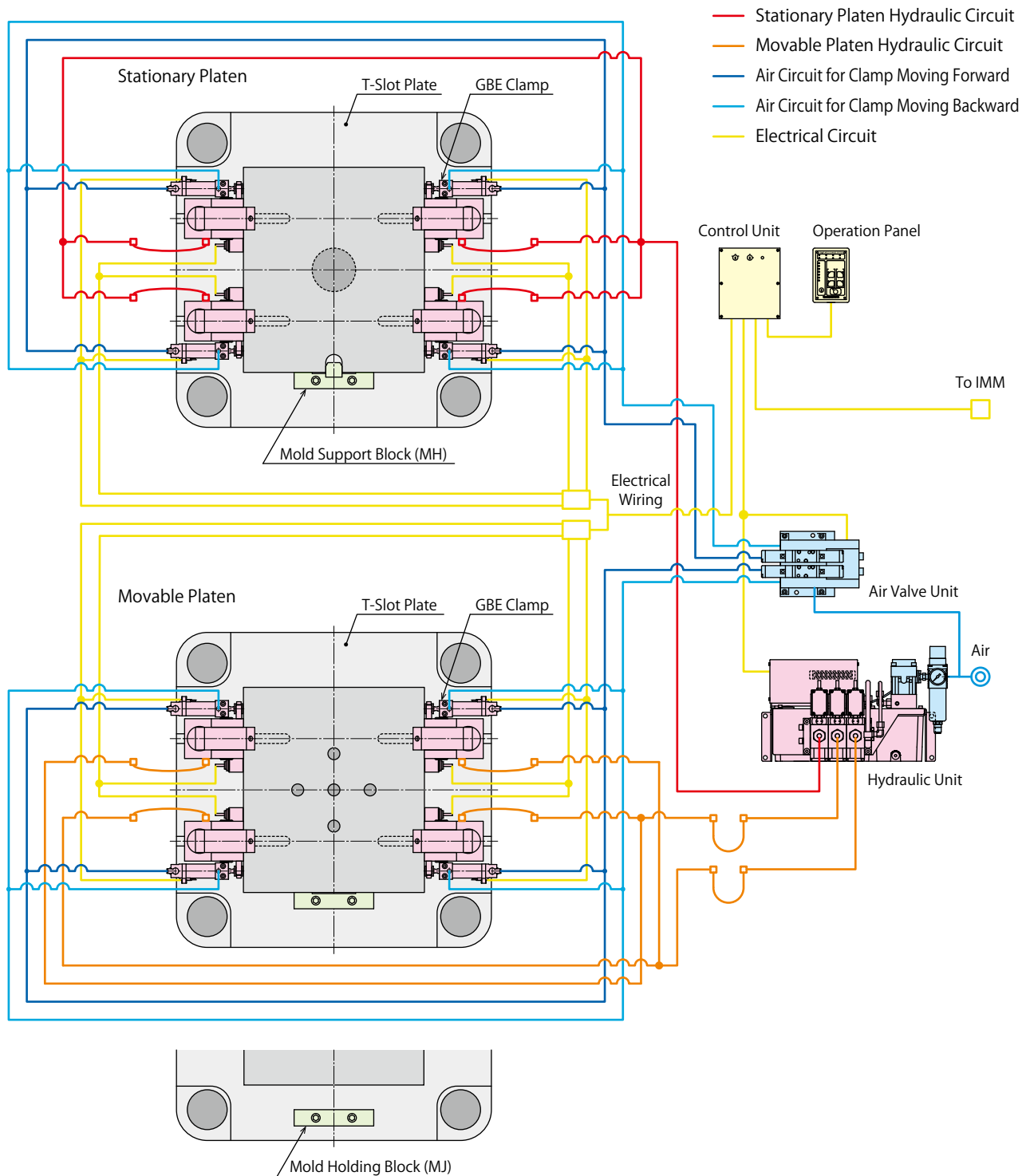

● Standard System

IMM Capacity (kN)	Clamp								Hydraulic Unit		Mold Support Block	Mold Holding Block	Air Valve Unit (GBE/GBF/GBR)
	GBB Clamp	GBE Clamp	GBC Clamp	GBF Clamp	GBM Clamp	GBR Clamp	Qty.	Stationary / Movable Clamping Capacity (kN)	Standard	High Speed			
~ 500	GBB0100	-	GBC0100	-	-	-	8	40	CPBN000-3UR-□0	CPDN000-3UR-□0	MH03	MJ0010	MV3013
~ 750	GBB0160	-	GBC0160	-	-	-	8	64			MH03	MJ0010	MV3013
~ 1500	GBB0250	GBE0250	GBC0250	GBF0250	GBM0250	GBR0250	8	100			MH04	MJ0020	MV3013
~ 2500	GBB0400	GBE0400	GBC0400	GBF0400	GBM0400	GBR0400	8	160			MH04	MJ0020	MV3013
~ 3500	GBB0630	GBE0630	GBC0630	GBF0630	GBM0630	GBR0630	8	252	CPDN000-3UR-□0	CPCN000-3UR-□0	MH04	MJ0020	MV3013
~ 5500	GBB1000	GBE1000	GBC1000	GBF1000	GBM1000	GBR1000	8	400			MH06	MJ0030	MV3023
~ 8500	GBB1600	GBE1600	GBC1600	GBF1600	GBM1600	GBR1600	8	640			MH06	MJ0040	MV3023
~ 13000	GBB2500	GBE2500	GBC2500	GBF2500	-	-	8	1000	CPCN000-3UR-□0	CPEN000-3UR-□0	MH08	MJ0050	MV3023
~ 20000	GBB4000	GBE4000	GBC4000	GBF4000	-	-	8	1600	CPEN000-3UR-□0		MH08	MJ0050	MV3033
~ 30000	GBB5000	GBE5000	GBC5000	GBF5000	-	-	8	2000	CQEN000-3UR-□0		CQEN000-3UR-□0	MH10	MJ0050

Note: 1. The list shows standard system references. Please contact us for unlisted systems.

## Vertical Loading Mold Change System

For Molds with Standardized Width

※ This drawing shows the system circuit reference for GWA clamp.

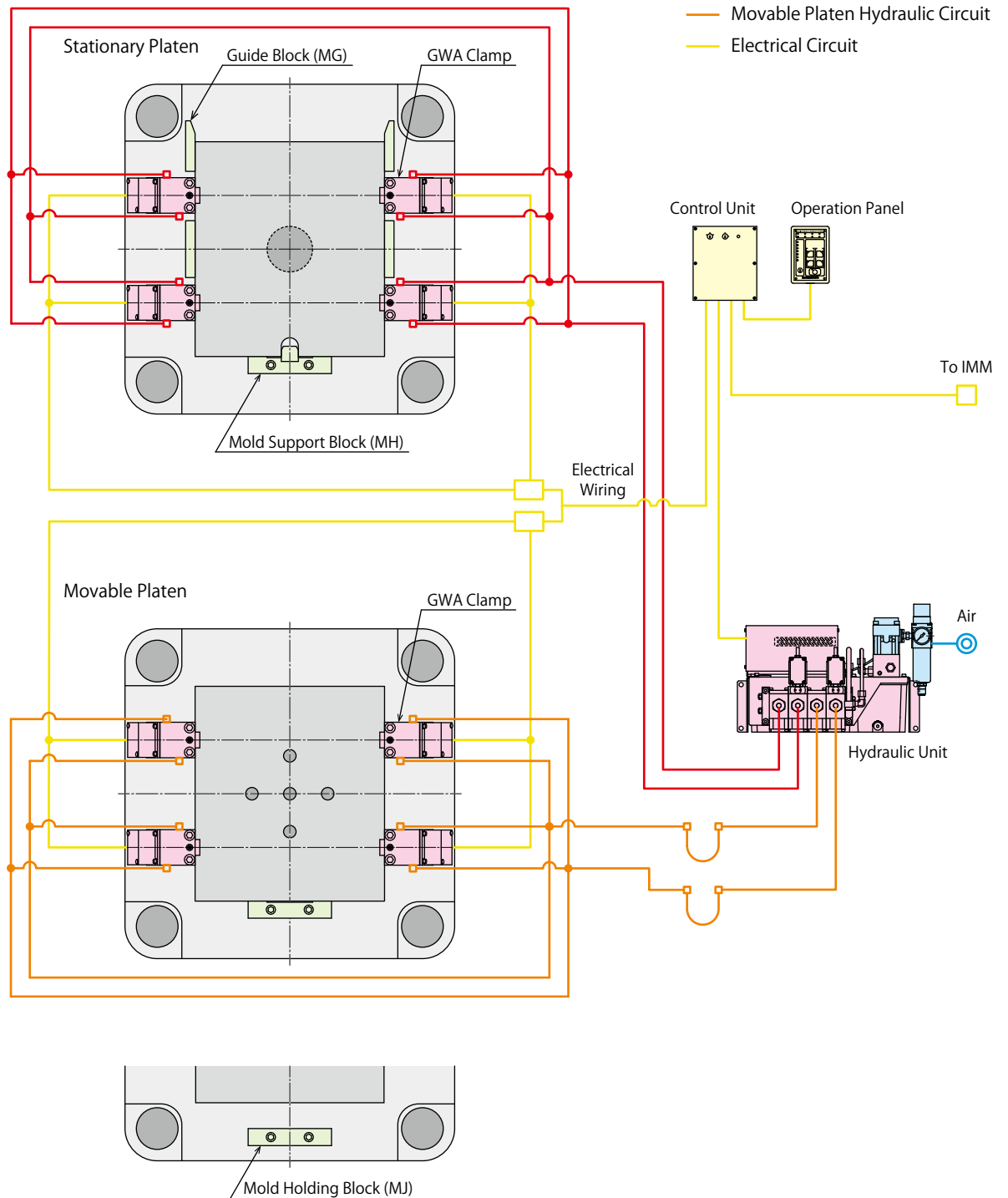

- Hydraulic Clamping System
- Hydraulic Clamp
- Hydraulic Unit
- Valve Unit
- Air Valve Unit
- Operational Panel Control Unit
- Auto Coupler
- Cautions
- Others

## Standard System

IMM Capacity (kN)	Clamp		Hydraulic Unit		Valve Unit IMM Hydraulic Source	Mold Support Block	Guide Block
	GWA Clamp	Qty. Stationary / Movable Clamping Capacity (kN)	Standard	High Speed			
~ 500	GWA0100	8 40	CPBL000-2PPR-□0	CPDL000-2PPR-□0	MV0011-5 (IMM Hydraulic Pressure 14MPa)	MH03	MG
~ 750	GWA0160	8 64				MH03	MG
~ 1500	GWA0250	8 100				MH04	MG
~ 2500	GWA0400	8 160				MH04	MG
~ 3500	GWA0630	8 252	CPDL000-2PPR-□0	CPCL000-2PPR-□0	MV0021-5 (IMM Hydraulic Pressure 14~21MPa)	MH04	MG
~ 5500	GWA1000	8 400	CPL000-2PPR-□0			MH06	MG
~ 8500	GWA1600	8 640	CPEL000-2PPR-□0			MH06	MG
~ 13000	GWA2500	8 1000	CQEL000-2PPR-□0	CQEL000-2PPR-□0	MV0061-5 (IMM Hydraulic Pressure 14~21MPa)	MH08	MG
~ 20000	GWA4000	8 1600				MH08	MG
~ 30000	GWA5000	8 2000				MH10	MG

Note: 1. The list shows standard system references. Please contact us for unlisted systems.

● Horizontal Loading Mold Change System

Needs to Standardize Mold Dimension

※ This drawing shows the system circuit reference for GWA clamp.

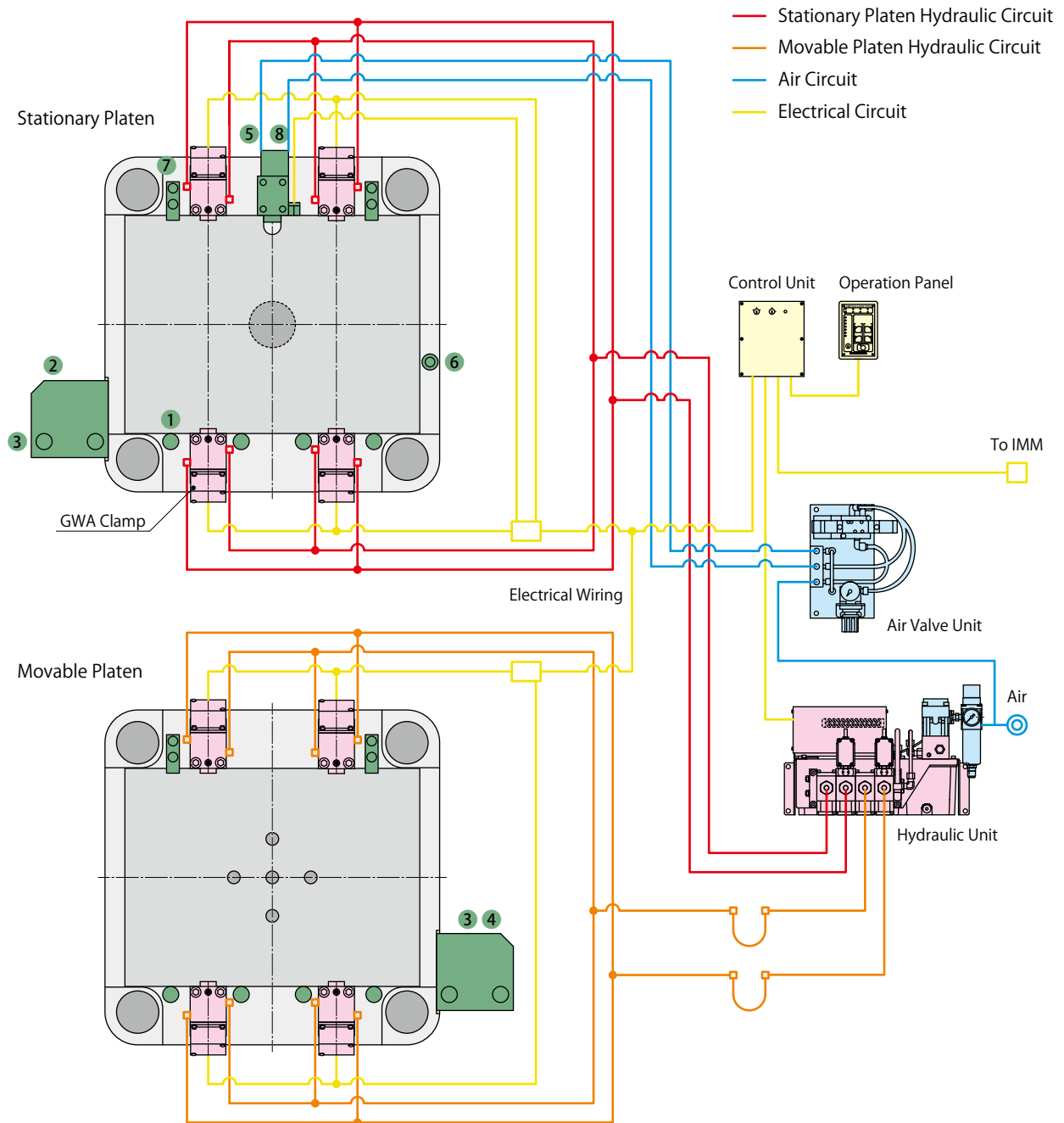

● Standard System

IMM Capacity (kN)	Clamp		Hydraulic Unit		Valve Unit IMM Hydraulic Source	Platen Components ※1 ※2		
	GWA Clamp	Qty. Stationary / Movable Clamping Capacity (kN)	Standard	High Speed		① Platen Roller	② Pre-Roller	③ Movable Platen Opening Upper Limit Detector
~ 500	GWA0100	8	40		MV0011-5 (IMM Hydraulic Pressure 14MPa)	MR0270	ML02	MS4011-5
~ 750	GWA0160	8	64	CPBL000-2PPR-□0		MR0270	ML02	MS4011-5
~ 1500	GWA0250	8	100			MR0400	ML04	MS4011-5
~ 2500	GWA0400	8	160			MR0400	ML04	MS4011-5
~ 3500	GWA0630	8	252	CPDL000-2PPR-□0	MV0021-5 (IMM Hydraulic Pressure 14~21MPa)	MR0400	ML04	MS4011-5
~ 5500	GWA1000	8	400	CPCL000-2PPR-□0		MR0600	ML06	MS4021-5
~ 8500	GWA1600	8	640	CPEL000-2PPR-□0		MR0800	ML08	MS4021-5
~ 13000	GWA2500	8	1000			MR1000	ML10	MS4031-5
~ 20000	GWA4000	8	1600	CQEL000-2PPR-□0	MV0061-5 (IMM Hydraulic Pressure 14~21MPa)	MR1600	ML16	MS4041-5
~ 30000	GWA5000	8	2000			MR1600	ML16	MS4041-5

Notes : ※1. Please refer to the circuit drawing and image drawing for details of platen components.

※2. Application of platen components may differ depending on IMM or mold conditions.

## Horizontal Loading Mold Change System

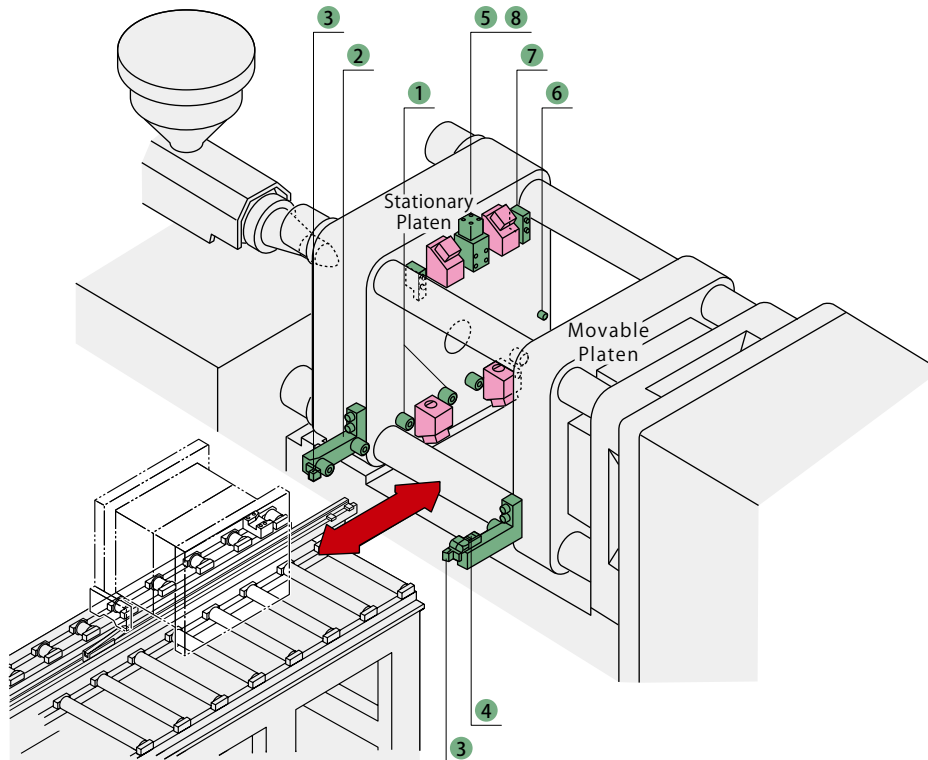

- Hydraulic Clamping System
- Hydraulic Clamp
- Hydraulic Unit
- Valve Unit
- Air Valve Unit
- Operational Panel Control Unit
- Auto Coupler
- Cautions Others

## Platen Components

- |  |  |
|--|--|
| <p><b>1</b> Platen Roller<br/>Transfers molds and positions in vertical direction toward the center of IMM nozzle.</p> <p><b>2</b> Pre-Roller<br/>Bridge from Platen Rollers to Safety Gate.</p> <p><b>3</b> Movable Platen Opening Upper Limit Detector<br/>In case the movable platen of IMM opens wider than the mold thickness (dimension D), it detects during mold loading and prevents the mold from falling from the platen roller or pre-roller.</p> <p><b>4</b> Movable Platen Opening Lower Limit Detector<br/>In case the movable platen of IMM opens narrower than mold thickness (dimension D), it detects during mold loading and stops the mold.</p> | <p><b>5</b> Mold Positioning Equipment<br/>Positions mold in horizontal direction during mold loading.</p> <p><b>6</b> Mold Stopper<br/>Prevents mold from overrunning due to the error of mold positioning equipment.</p> <p><b>7</b> Mold Safety Retainer<br/>When the movable platen opens too wide after releasing clamps, it will prevent the mold from falling.</p> <p><b>8</b> Mold Detection<br/>Confirms the presence of mold in IMM.</p> |
|--|--|

Platen Components ※1 ※2				Standard
4 Movable Platen Opening Lower Limit Detector	5, 8 Mold Positioning Device	6 Mold Stopper	7 Safety Retainer	Mold Weight (t)
MS2030-5 (Limit Switch)	MP03	MM	MF0010	0.6
	MP03		MF0010	0.6
	MP04		MF0010	1.0
	MP04		MF0010	1.5
MS2041-5 (Proximity Switch)	MP06		MF0010	2.5
	MP06		MF0020	4.5
	MP08		MF0020	8.0
	MP08		MF0030	15
	MP08		MF0030	20
	MP10		MF0040	30

# Hydraulic Clamp

Longer Stroke / T-Slot Automatic-Slide

Model GBF

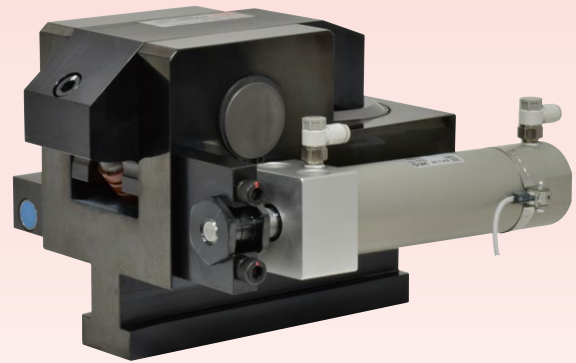

## GBC Clamp with an Air Cylinder

Automatic slide clamp with longer stroke allows for variation in mold clamping thicknesses. Clamp movement is automated. PAT.

### ● Action Description

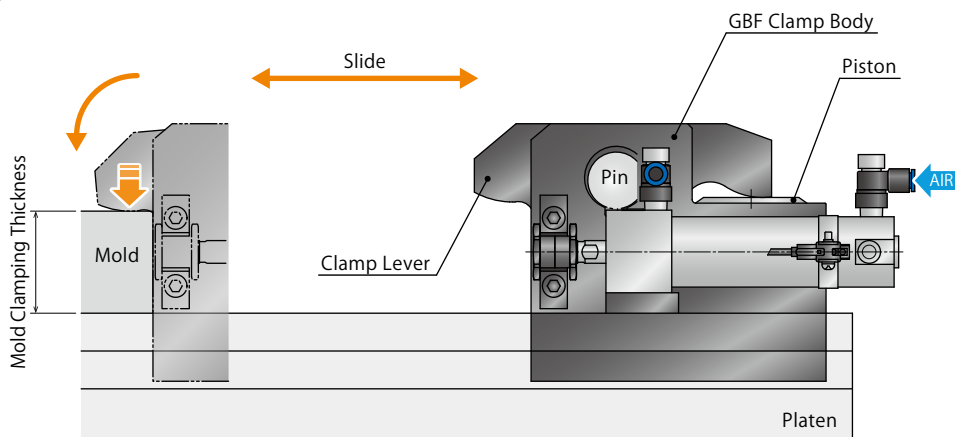

#### Locked State

GBF clamp moves forward with the air supply to the air cylinder.  
Supply hydraulic pressure after mold detection of proximity switch.  
The piston is lifted up, and the clamp lever pivots on the pin and locks the mold.

Forward End Detection  ON  
Backward End Detection  OFF

#### Released State

When hydraulic pressure is released, the piston descends with built-in spring force and the clamp lever is at released state.  
After that, supply the air to the air cylinder and GBF clamp moves backward automatically.  
(The backward-end detection switch detects that the GBE clamp moves backward.)

Forward End Detection  OFF  
Backward End Detection  ON

※ We provide GBF clamp according to the mold clamping thickness and T-slot dimension.  
Please refer to the external dimensions for detail.

## System Structure Example

The basic structure with GBF clamp that is slid automatically in the T-slot by the air cylinder.

This system is able to control one stationary platen circuit and two movable platen circuits with a three-circuit hydraulic unit.

Clamps are slid by the air valve unit.

- Hydraulic Clamp : GBF Clamp
- Hydraulic Unit : CP□□ Unit
- Air Valve Unit : MV30□3 Valve Unit

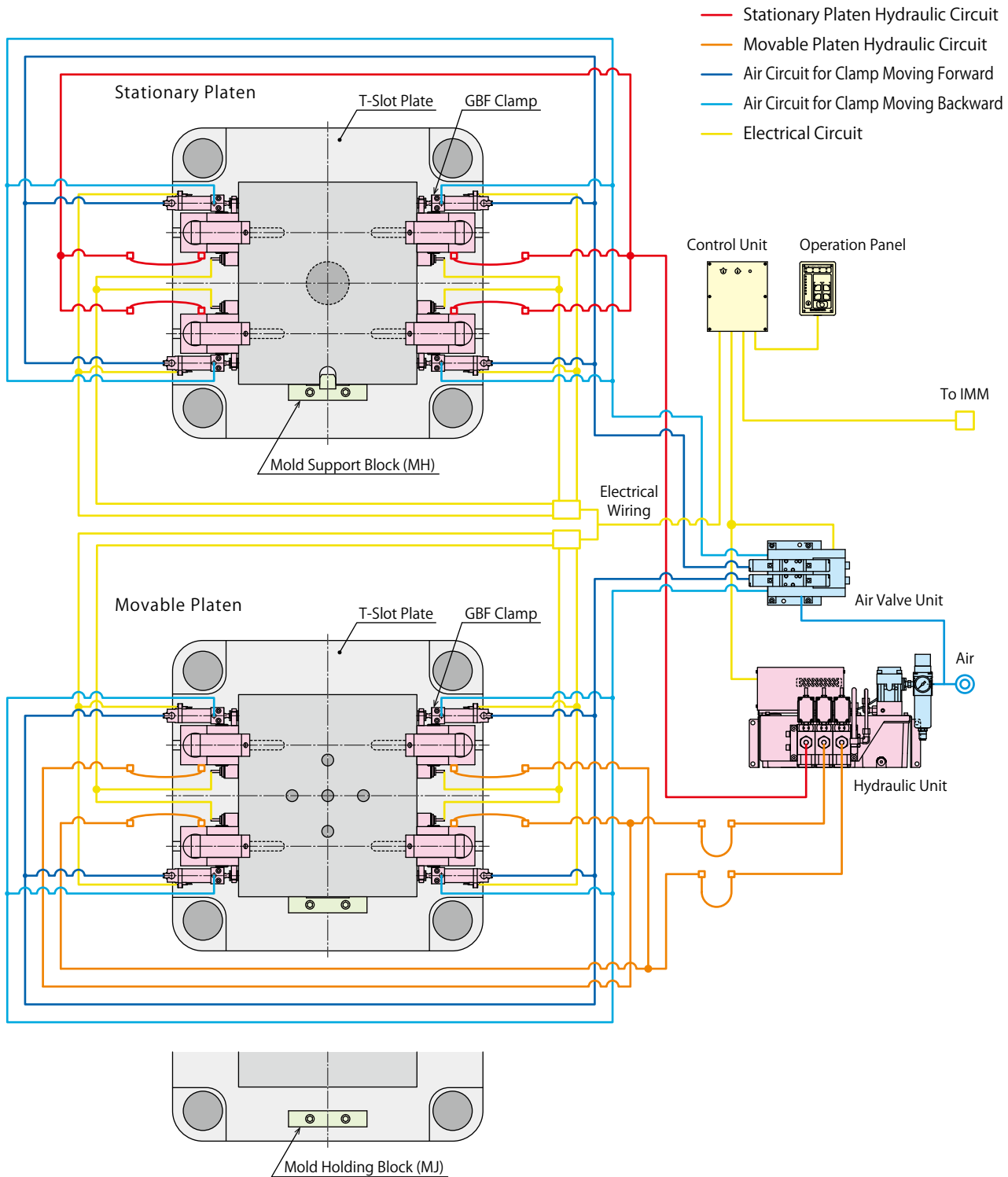

- Hydraulic Clamping System
- Hydraulic Clamp**
- Hydraulic Unit
- Valve Unit
- Air Valve Unit
- Operational Panel Control Unit
- Auto Coupler
- Cautions Others

T-Slot Manual-Slide Model  
G B B

T-Slot Auto-Slide Model  
G B E

Long Stroke T-Slot Manual-Slide Model  
G B C

**Long Stroke T-Slot Auto-Slide Model**  
G B F

Manual Block-Slide Model  
G B M

Automatic Block-Slide Model  
G B R

Fixed Bolt Model  
G W A

T-Slot Auto-Slide Model  
G L A

Model No. Indication

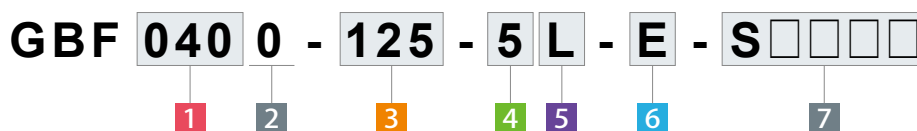

**1 Clamping Force**

- |                                    |                                    |
|------------------------------------|------------------------------------|
| <b>025</b> : Clamping Force= 25kN  | <b>160</b> : Clamping Force= 160kN |
| <b>040</b> : Clamping Force= 40kN  | <b>250</b> : Clamping Force= 250kN |
| <b>063</b> : Clamping Force= 63kN  | <b>400</b> : Clamping Force= 400kN |
| <b>100</b> : Clamping Force= 100kN | <b>500</b> : Clamping Force= 500kN |

**2 Design No.**

**0** : Revision Number

**3 Slide Stroke (Air Cylinder Stroke)**

- 25** : Clamp Travel Distance = 25mm  
 ?
- 300** : Clamp Travel Distance = 300mm

※ Selectable **3** Slide Stroke differs according to **1** Clamping Force.  
 Please refer to the slide stroke on specifications.  
 ※ Extra distance should be considered when determining the travel distance.

**4 Switch Load Voltage (Current)**

- 1** : AC100V  
**2** : AC200V  
**5** : DC24V (5~40mA)

**5 Air Cylinder Mounting Position**

- L** : Left (Left Side as Seen from Clamp Back Side)  
**R** : Right (Right Side as Seen from Clamp Back Side)

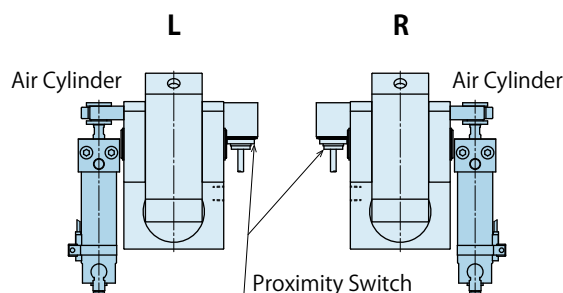

**6 Option** ※ Please contact us for specifications/external dimensions.

- Blank** : Standard
- E** : Reinforced Body
- H** : Extra Height Body (When h dimension is more than max. h dimension shown in the external dimension.)
- J** : Low Lever (When h dimension is less than min. h dimension shown in the external dimension.)
- K** : Rear Port
- L**□ : Wide Lever (For U-Cut of Mold) ※1
- N** : NPT Port ※2
- Q** : Double Cylinder
- R** : Longer D Dimension of T-Leg
- R3** : Anti-Rust (Special coating, additional packing) (Only for GBF0400~2500)
- S** : Special Spacer
- U**□ : With Grease Nipple (Only for GBF0400~2500) (Standard Option for GBF4000/GBF5000.)
- V** : High Temperature (0~120°C) ※3

Notes:  
 ※1. Please indicate the U-cut dimension of the mold.  
 ※2. Dimensions in the specification sheet and other documents are in inches.  
 ※3. Select the hydraulic unit with pressure relief valve when using under high temperature since there may be pressure fluctuation caused by temperature change.

**7 Production Number**

This number represents the main specification of the clamp's T-slot stem and the clamping height. After the specification is confirmed, we will create a number.

## Specifications

Model No.	GBF0250	GBF0400	GBF0630	GBF1000	GBF1600	GBF2500	GBF4000	GBF5000	
GBC Clamp Model No.	GBC0250	GBC0400	GBC0630	GBC1000	GBC1600	GBC2500	GBC4000	GBC5000	
Clamping Force	kN	25	40	63	100	160	250	400	500
Working Pressure	MPa	25 (For Rated Clamp Force)							
Withstanding Pressure	MPa	37							
Slide Stroke Range	mm	25~200	25~200	50~200	50~200	50~300	50~300	50~300	50~300
Full Stroke	mm	10	12	15	15.5	16	16	16	16.5
Clamp Stroke	mm	1.5	3.5	1	1.5	2	2	2	2.5
Extra Stroke	mm	8.5	8.5	14	14	14	14	14	14
Allowable Thickness Variance of Mold Back-Plate	mm	5	5	10	10	10	10	10	10
Cylinder Capacity (At Full Stroke)	cm <sup>3</sup>	10	19	38	63	105	160	253	331
Operating Air Pressure	MPa	0.4~0.5							
Operating Temperature ※4	°C	0~70 (V: High temperature option is available for 0~120°C)							
Use Frequency ※5		Less than 20 Cycles / Day							
Usable Fluid ※6 ※7 ※8		General Hydraulic Oil Equivalent to ISO-VG-32							
Min. T-Slot Width a (JIS) ※9	mm	14	18	22	24	28	36	36	36 (2 T-Legs)
Max. T-Slot Width a (JIS) ※9	mm	32	42	42	54	54	54	54	42 (2 T-Legs)

### Notes :

- ※4. Option **V** : High Temperature (0~120°C) is for operating in temperatures of 70°C or more.
- ※5. Please contact us for more frequent use.
- ※6. Please contact us for fluids other than those mentioned on the list.
- ※7. If hydraulic viscosity is higher than specified, action time will be longer.
- ※8. If using it at low temperature, action time will be longer because the viscosity of hydraulic oil becomes higher.
- ※9. It shows reference dimensions. The dimension may differ from specification depending on T-slot (T-leg) dimension, dimension of clamp cylinder that sticks out of T-slot during lock action, or body material.
  1. Please supply the air cylinder with more than 0.4MPa of air pressure and adjust the moving speed of the clamp with speed controller to fully stroke within 1 to 2 seconds.
  2. Please refer to GBC clamp pages (p. 19-24) for details of clamp body.

Hydraulic  
Clamping System

Hydraulic Clamp

Hydraulic Unit

Valve Unit

Air Valve Unit

Operational Panel  
Control Unit

Auto Coupler

Cautions  
OthersT-Slot  
Manual-Slide Model

GBB

T-Slot  
Auto-Slide Model

GBE

Long Stroke T-Slot  
Manual-Slide Model

GBC

Long Stroke T-Slot  
Auto-Slide Model

GBF

Manual  
Block-Slide Model

GBM

Automatic  
Block-Slide Model

GBR

Fixed Bolt Model

GWA

T-Slot  
Auto-Slide Model

GLA

External Dimensions

※ This drawing shows GBF0250 ~ GBF4000 standard model.  
 Contact us for external dimensions for options.  
 Please refer to GBC clamp pages (p. 19-24) for details of clamp body.

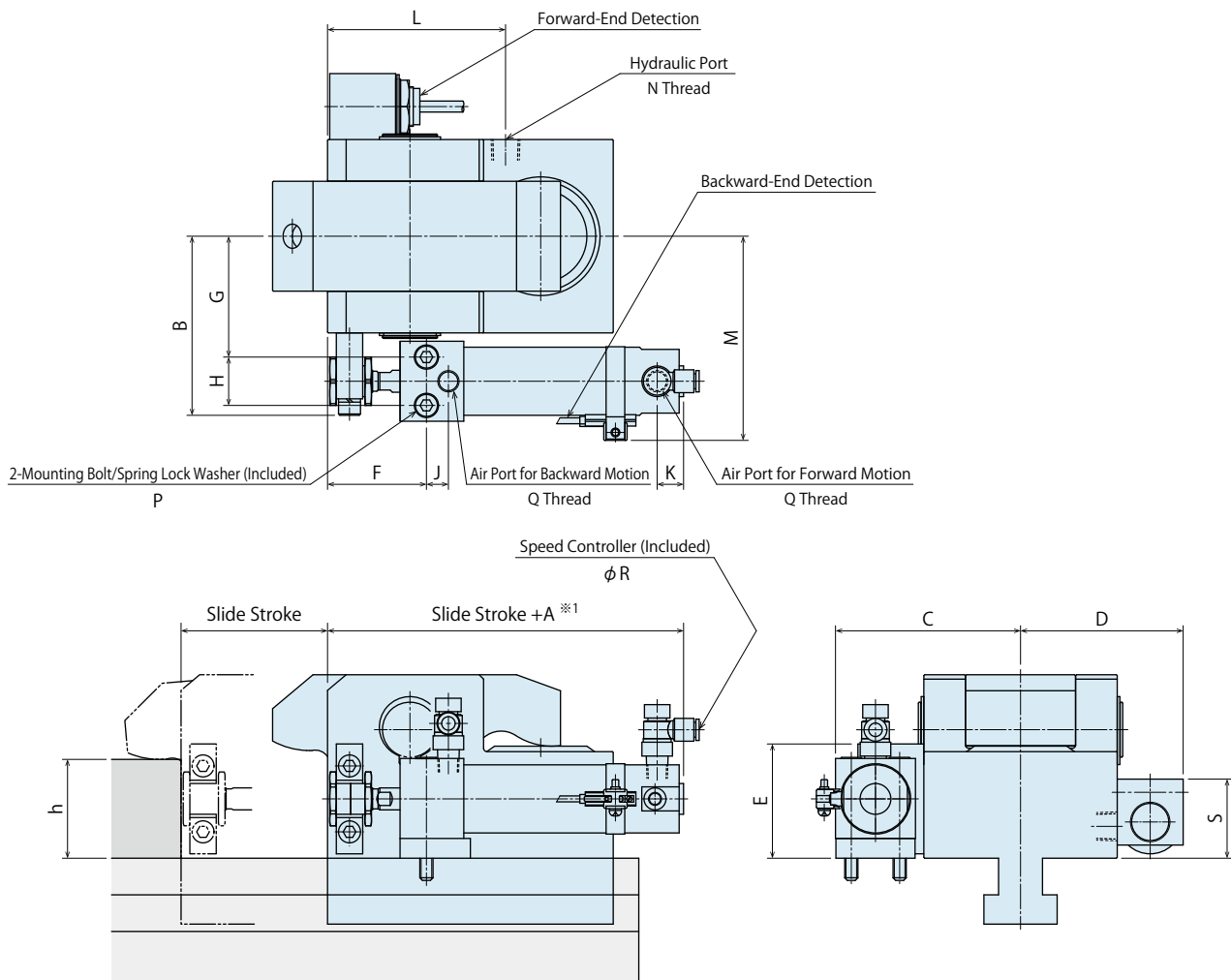

※ GBF5000 has two T-legs.  
 Contact us for external dimensions for options.  
 Please refer to GBC clamp pages (p. 19-24) for details of clamp body.

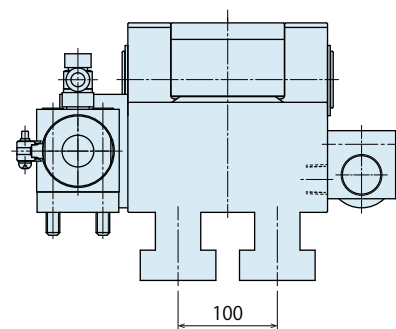

T-Slot Dimensions

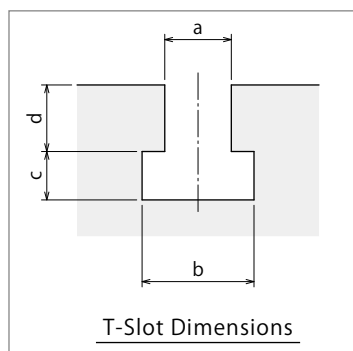

Notes :

1. Do not exceed the clamping force on the specification.
2. Specifications/Contents in this catalog are subject to change without prior notice. Ask for the approval drawing before deciding to purchase.

## External Dimension List

(mm)

Model No.	GBF0250	GBF0400	GBF0630	GBF1000	GBF1600	GBF2500	GBF4000	GBF5000
GBC Clamp Model No.	GBC0250	GBC0400	GBC0630	GBC1000	GBC1600	GBC2500	GBC4000	GBC5000
Full Stroke	10	12	15	15.5	16	16	16	16.5
Clamp Stroke	1.5	3.5	1	1.5	2	2	2	2.5
Extra Stroke	8.5	8.5	14	14	14	14	14	14
Allowable Thickness Variance of Mold Back-Plate	5	5	10	10	10	10	10	10
A ※1	105	105	112	118	136	157	184	184
B	60.5	65.5	81.5	92.5	112	137	189	201.5
C	63.5	68.5	84.5	94.5	116.5	142	218.5	231
D	59	64	74	78.5	88.5	102	117.5	130
E	37	37	52	58	70.5	81	119	119
F	39	39	45	46	56	64	57	57
G	39	44	55	61	74	89	106.5	119
H	18	18	22	24	32	41	96	96
J	9	9	10	13	14	16	36	36
K ※1	12	12	12	12	12	14	19	19
L	75.5	93.5	81	91	126	170.5	215	250
M	72.5	77.5	93	103.5	125	150.5	213.5	226
N	Rc1/8	Rc1/4	Rc1/4	Rc1/4	Rc1/4	Rc1/4	Rc3/8	Rc3/8
P	M5x0.8x40	M5x0.8x40	M6x50	M8x55	M10x70	M12x85	M16x130	M16x130
Q	Rc1/8	Rc1/8	Rc1/8	Rc1/8	Rc1/8	Rc1/4	Rc3/8	Rc3/8
R ※2	6	6	6	6	6	10	10	10
S	40.5	40.5	36	36	36	36	36	36
min. h	25~30	25~30	30~40	40~50	40~50	45~55	50~60	60~70
max. h	45~50	45~50	50~60	60~70	70~80	70~80	75~85	75~85

## Notes :

- ※1. "A" and "K" dimensions are different when exceeding the stroke value written in the list. Please contact us for detail.
- ※2. For -N : NPT Port, "R" dimension is in inches.
  1. Please adjust the moving speed of the clamp with speed controller to fully stroke within 1 to 2 seconds.
  2. If you would like to change the ratio of clamp stroke and extra stroke, please contact us.
  3. When making an order, please specify a, b, c, d dimension of T-slot and h dimensions of mold clamping thickness.
  4. Please refer to GBC clamp pages (p. 19-24) for unlisted dimensions.

## Slide Stroke List

Model No.	Slide Stroke (mm)								
	25	50	75	100	125	150	200	250	300
GBF0250	○	○	○	○	○	○	○	○	
GBF0400	○	○	○	○	○	○	○	○	
GBF0630		○	○	○	○	○	○	○	
GBF1000		○	○	○	○	○	○	○	
GBF1600		○	○	○	○	○	○	○	○
GBF2500		○	○	○	○	○	○	○	○
GBF4000		○	○	○	○	○	○	○	○
GBF5000		○	○	○	○	○	○	○	○

## Note :

1. "A" and "K" dimensions are different when exceeding the stroke value written in the list. Please contact for detail.

## GBF Clamp Minimum Mold Back Plate Depth

Minimum Mold Back Plate Depth

(mm)

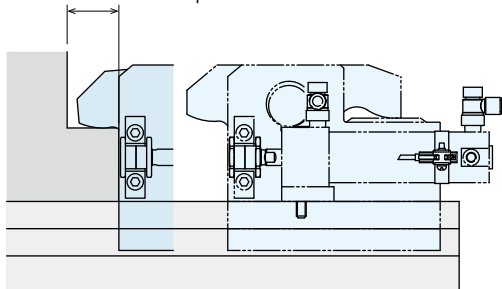

Model No.	Minimum Mold Back Plate Depth
GBF0250	20
GBF0400	23
GBF0630	26.5
GBF1000	31.5
GBF1600	32
GBF2500	31.5
GBF4000	36
GBF5000	38

## Notes :

1. The above dimensions are approximate and referenced from our standard models.

Hydraulic Clamping System

Hydraulic Clamp

Hydraulic Unit

Valve Unit

Air Valve Unit

Operational Panel Control Unit

Auto Coupler

Cautions Others

T-Slot Manual-Slide Model

GBB

T-Slot Auto-Slide Model

GBE

Long Stroke T-Slot Manual-Slide Model

GBC

Long Stroke T-Slot Auto-Slide Model

GBF

Manual Block-Slide Model

GBM

Automatic Block-Slide Model

GBR

Fixed Bolt Model

GWA

T-Slot Auto-Slide Model

GLA

**Cautions**

**Notes for Design**

1) Check Specifications

- Please use each product according to its specifications.
- **【GBB/GBC/GBE/GBF/GBM/GBR】**  
Operating hydraulic pressure is 25 MPa.  
Operate within the specified condition. Failure to do so may result in damage on clamps, falling of molds and injury.  
In order to reduce clamping force, use the product with lower operating pressure.

**【GWA/GLA】**

Operating hydraulic pressure is 14MPa. Hydraulic pressure must be continuously supplied.  
However, if using IMM hydraulic source and supply hydraulic pressure fluctuates, supply 14MPa hydraulic pressure to the clamp when opening the mold. Otherwise, the specification of the clamp is not satisfied and it may cause injury due to falling of the mold.

Do not use clamps with excessive hydraulic pressure. Failure to do so may result in damage on clamps, falling of molds and injury.

- The ambient operating temperature of clamp should be 0 ~ 70°C. (High Temperature Model : 0 ~ 120°C.)

2) Mold Clamping Thickness

- **【GBB/GBC/GBE/GBF/GBM/GBR】**  
Check the mold clamping thickness.

**【GWA/GLA】**

The mold clamping thickness should be  $h \pm 0.5\text{mm}$ .

- Use of a mold other than specified may result in incomplete locking of the clamp, leading to injury due to falling of the mold.

3) Check the dimensions of T-slot.

- **【GBB/GBC/GBE/GBF/GLA】**  
If the T-slot you are using differs from the clamp specification, the clamp will not operate properly, and this could lead to falling of the mold and injury.

4) Allowable Protrusion Amount when Clamping

- **【GBB/GBC/GBE/GBF/GWA/GLA】**  
Do not exceed the allowable protrusion amount. Otherwise, excessive force will be applied to the clamp, deforming or dropping the clamp out of T-slot. It may cause falling of a mold and injury.

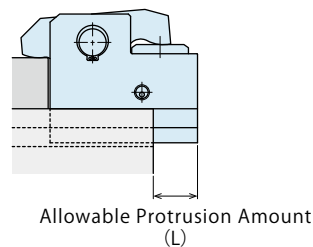

Model No.	L (mm)
<b>GBB0100/GBC0100</b>	17.5
<b>GBB0160/GBC0160</b>	21
<b>GBB0250/GBC0250/GBE0250/GBF0250</b>	25
<b>GBB0400/GBC0400/GBE0400/GBF0400</b>	32
<b>GBB0630/GBC0630/GBE0630/GBF0630</b>	39
<b>GBB1000/GBC1000/GBE1000/GBF1000</b>	45
<b>GBB1600/GBC1600/GBE1600/GBF1600</b>	57
<b>GBB2500/GBC2500/GBE2500/GBF2500</b>	69.5
<b>GBB4000/GBC4000/GBE4000/GBF4000</b>	0
<b>GBB5000/GBC5000/GBE5000/GBF5000</b>	0

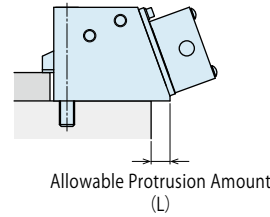

Allowable Protrusion Amount

Model No.	L (mm)
<b>GWA0100/GLA0100</b>	35
<b>GWA0160/GLA0160</b>	38
<b>GWA0250/GLA0250</b>	23
<b>GWA0400/GLA0400</b>	62
<b>GWA0630/GLA0630</b>	65
<b>GWA1000/GLA1000</b>	35
<b>GWA1600/GLA1600</b>	0
<b>GWA2500/GLA2500</b>	0
<b>GWA4000/GLA4000</b>	0
<b>GWA5000/GLA5000</b>	0

5) Be careful with a mounting position of a clamp.

- **【GBM/GBR】**

The mounting block should not protrude out from the mounting surface. Otherwise, excessive force will be applied to the clamp leading to deformation and dislocation which may cause falling of a mold leading to injury.

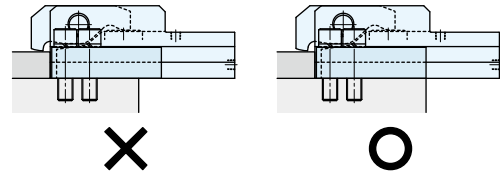

6) Make sure the sliding surface is smooth (without any bumps).

- **【GBB/GBC/GBE/GBF/GBM/GBR/GLA】**

If the sliding surface is not smooth, the clamp will not slide properly.

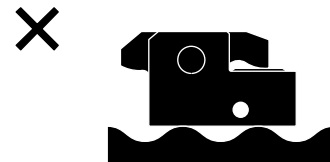

7) Mold clamping surface

- **【GBB/GBC/GBE/GBF/GBM/GBR】**

The mold clamping surface and T-slot must be parallel to the mold mounting surface. If the clamping surface has a bump or is not flat, excessive force will be applied to the clamp. It may deform the clamp body, lever and pins, resulting in falling of the clamp or the mold and injury.

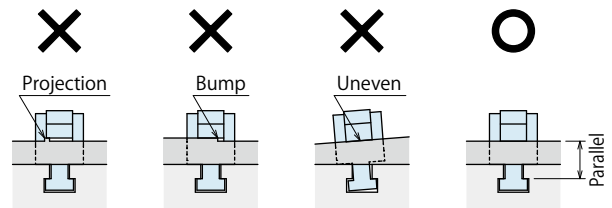

- **【GWA/GLA】**

The mold clamping surface must be parallel to the IMM platen. If the clamping surface has a bump or is not flat, excessive force will be applied to the clamp. It may deform the clamp body and the clamp piston, resulting in falling of the mold and injury.

- 8) Make sure there is no notch such as U-cut on the clamping area of the mold.
- If there are U-cuts (notches) on the clamping area of a mold, the clamp will not be able to operate properly, leading to falling of the mold and injury.
- For use of molds with U-cuts (notches), please contact us.

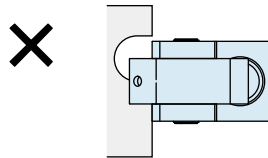

- 9) Make sure there is no notch such as U-cut on the mold surface where the mold confirmation proximity switch contacts.
- The mold confirmation proximity switch does not operate properly if there are U-cuts (notches) on the mold surface where the mold confirmation proximity switch contacts.

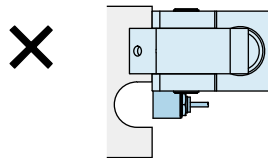

- 10) Make sure that advance/retraction of the clamp is smoothly conducted.
- **【GBE/GBF/GBR/GLA】**
  - ① Supply more than 0.4MPa air pressure to air cylinder.
  - ② Adjust the moving speed of the clamp with speed controllers to fully stroke within 1 to 2 seconds.
  - ③ Proximity switch is used for forward-end confirmation. Make sure the mold surface on the switch side has no U-cut.
  - ④ The clamp sliding surface must be smooth (without any bumps).
- 11) Interlock
- Make sure to control with the interlock so that clamps lock or release only when IMM is at mold close (pressurized) state.

- 12) Design the hydraulic circuit carefully.

- **【GWA/GLA】**
- When designing the hydraulic circuit, make sure to install a check valve in the circuit. Install a pressure relief valve in case the oil temperature in the circuit increases while clamping, since the pressure may exceed the value in the specification. Clamp damage may lead to falling of a mold and injury.

**【Reference Circuit】**

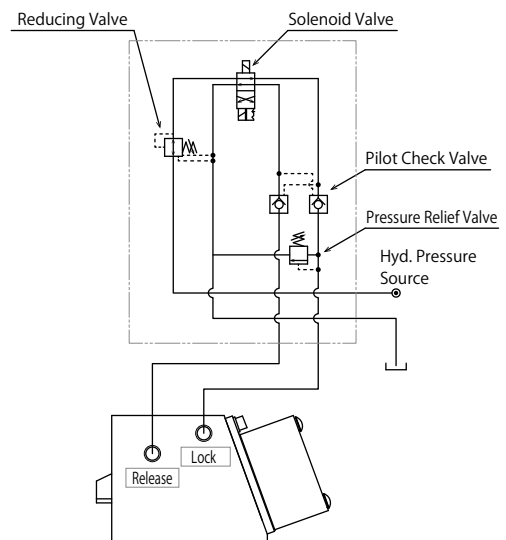

- 13) Control the solenoid valve carefully.

- **【GWA/GLA】**
- When controlling the solenoid valve, always energize the excitation circuits. If not energize the excitation circuits, it may be switched by unexpected causes resulting in falling of a mold and injury.

- 14) Clamp control

- **【GWA/GLA】**
- A micro switch of mechanical interface is used for confirming the lock/release operation. It may happen to disconnect the connection of the switch caused by vibration during the machine running.
- It is recommended to install an off-delay timer in the control circuits of the program.

**Cautions**

**Installation Notes**

- 1) Prevent the clamps dropping out from the T slot.
  - 【GBB/GBC/GBE/GBF/GLA】
  - Fall of the clamp will lead to injury.

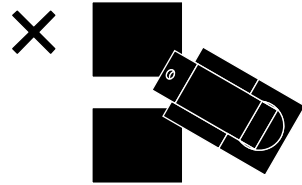

- 2) Check the Usable Fluid.
  - Use the appropriate fluid by referring to the Hydraulic Fluid List. Please contact us when using fluid which is not on the list.
- 3) Procedure before piping
  - The pipeline and piping connector should be cleaned by thorough flushing. The dust and cutting chips in the circuit may lead to fluid leakage and malfunction. (The filter which removes contaminant in the hydraulic piping or hydraulic system is not provided.)
- 4) Please supply filtered clean dry air.
  - Install an air filter/air dryer in order to prevent rust and dirt. Otherwise it may lead to malfunction.
- 5) Applying Sealing Tape
  - Wrap with tape 1 to 2 times following the screwing direction. When piping, be careful that contaminants such as sealing tape do not enter in products. Pieces of the sealing tape can lead to fluid leakage and malfunction.

- 6) Installation of the Clamp
  - 【GBE/GBF/GLA】
  - After setting the clamp in the T-slot, use attached hex. socket bolts and tighten them with the torque shown below.

Model No.	Bolt Size	Tightening Torque (N·m)
GBE/GBF025□	M5×0.8	6.3
GBE/GBF040□	M5×0.8	6.3
GBE/GBF063□	M6×1	10
GBE/GBF100□	M8×1.25	25
GBE/GBF160□	M10×1.5	50
GBE/GBF250□	M12×1.75	80
GBE/GBF400□	M16×2	200
GBE/GBF500□	M16×2	200

Model No.	Bolt Size	Tightening Torque (N·m)
GLA160□	M12×1.75	80
GLA250□	M16×2	200
GLA400□	M20×2.5	400
GLA500□	M20×2.5	400

**【GBM/GBR】**

After setting the clamp, use attached hex. socket bolts and tighten them with the torque shown below.

Model No.	Bolt Size	Tightening Torque (N·m)
GBM/GBR025□	M12×1.75	80
GBM/GBR040□	M16×2	200
GBM/GBR063□	M20×2.5	400
GBM/GBR100□	M24×3	630
GBM/GBR160□	M30×3.5	1250

**【GWA】**

Use attached hex. socket bolts and tighten them with the torque shown below.

Model No.	Bolt Size	Tightening Torque (N·m)
GWA010□	M8×1.25	25
GWA016□	M10×1.5	50
GWA025□	M12×1.75	80
GWA040□	M16×2	200
GWA063□	M20×2.5	400
GWA100□	M24×3	630
GWA160□	M20×2.5	400
GWA250□	M24×3	630
GWA400□	M30×3.5	1250 (800)
GWA500□	M33×3.5	1600 (1000)

Note: The table shows tightening torque when bolts and screw parts are dry. Values in brackets indicate values when the bolt seating surfaces and screw parts are lubricated with grease.

- 7) Piping and Wiring
  - For piping and wiring, make sure not to cut the hydraulic hoses and wiring by the clamp when it moves back and forth.
- 8) Air Bleeding of the Hydraulic Circuit
  - Excessive air in the hydraulic circuit may result in insufficient clamping force or a longer operating time. If air enters the circuit after connecting the pipes or when the oil tank is empty, bleed air at the ends of the pipes.
- 9) Wiring of Forward End Confirmation Switch
  - For wiring, please make sure that the clamp does not cut the code of Forward End Confirmation Switch when it moves back and forth.

## ● Hydraulic Fluid List

ISO Viscosity Grade ISO-VG-32

Maker	Anti-Wear Hydraulic Oil	Multi-Purpose Hydraulic Oil
Showa Shell Sekiyu	Tellus S2 M 32	Morlina S2 B 32
Idemitsu Kosan	Daphne Hydraulic Fluid 32	Daphne Super Multi Oil 32
JX Nippon Oil & Energy	Super Hyrando 32	Super Mulpus DX 32
Cosmo Oil	Cosmo Hydro AW32	Cosmo New Mighty Super 32
ExxonMobil	Mobil DTE 24	Mobil DTE 24 Light
Matsumura Oil	Hydol AW-32	
Castrol	Hyspin AWS 32	

Note: Please contact manufacturers when customers require products in the list above.

Hydraulic  
Clamping System

Hydraulic Clamp

Hydraulic Unit

Valve Unit

Air Valve Unit

Operational Panel  
Control Unit

Auto Coupler

Cautions  
Others

**Cautions**

**Notes on Handling**

- 1) Close the mold after molding is completed.
  - Failure to do so may result in mold dropping and injury.
- 2) It should be handled by qualified personnel.
  - The hydraulic/pneumatic equipment should be handled and maintained by qualified personnel.
- 3) Do not handle or remove the product unless the safety protocols are ensured.
  - ① The machine and equipment can only be inspected or prepared when it is confirmed that the preventive devices are in place.
  - ② Before removing the product, make sure that the above-mentioned safety measures are in place. Shut off the pressure and power source, and make sure no pressure exists in the hydraulic circuits.
  - ③ After stopping the product, do not remove until the equipment cools down.
  - ④ Make sure there is no abnormality in the bolts and respective parts before restarting the machine or equipment.
- 4) Do not apply load to the clamp when at 0MPa.
  - In case of hydraulic source trouble, the clamp has holding force with mechanical lock even when hydraulic pressure is at 0MPa. However, do not apply load on the clamp at this state.
- 5) Do not touch clamps while they are working.
  - Otherwise, your hands may be injured.

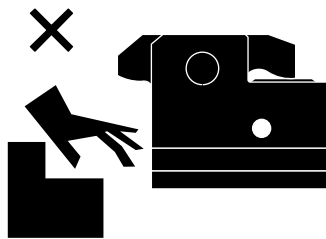

- 6) When changing a mold width, make sure to check the allowable protrusion amount.
  - If using it with beyond allowable protrusion amount, excessive force is applied to the clamp which deforms or damages the clamp resulting in falling of the mold and injury. It may cause product malfunction or deterioration, which may lead to an accident.

- 7) Hold the clamp body when moving and removing the clamp.
  - Pulling on a hose leads to a clamp fall and injury. Also, rivet part of the hose will be loosened leading to fluid leakage.

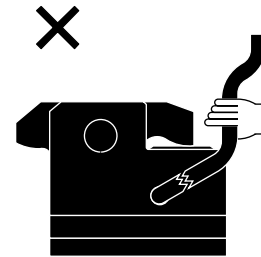

- 8) Do not pour water or oil over the product.
  - It may lead to malfunction or deterioration of the product and cause an accident.

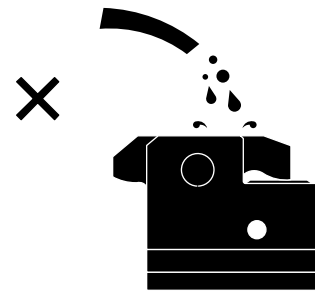

- 9) Do not disassemble or modify.
  - If the product is taken apart or modified, the warranty will be voided even within the warranty period.
- 10) Do not apply excessive force to clamps.
  - The clamp may be damaged or deformed, resulting in malfunction.

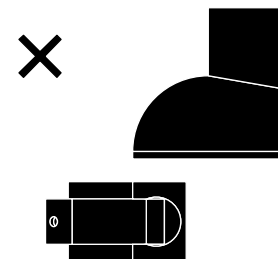

## ● Maintenance and Inspection

- 1) Removal of the Product and Shut-off of Pressure Source
    - Before removing the product, make sure that the safety measures mentioned earlier are in place. Shut off the pressure and power source, and make sure no pressure exists in the air/hydraulic circuits.
- Also, make sure there is no abnormality in the bolts and respective parts before restarting.

- 2) Lubricate grease periodically.

### 【GWA/GLA】

- Lubricate grease from the grease nipple periodically (once a year is recommended) to maintain clamp performance. Especially when process water often splashes on the clamps, release operation failure is likely to occur. In such cases, lubricate the clamps with grease more frequently than recommended, if necessary.

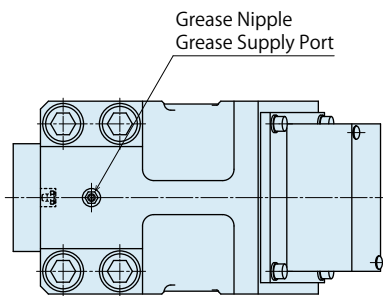

If release operation failure should occur, it is effective to lubricate grease and repeat lock and release actions of the clamp 2 to 3 times without the mold.

- 3) Regularly tighten pipes and mounting bolts to ensure proper use.
- 4) Periodically ensure that the supply hydraulic/air pressure is a specified value.
- 5) Make sure the hydraulic fluid has not deteriorated.
- 6) Make sure there is a smooth action without an irregular noise. (Especially when it is restarted after left unused for a long period, make sure it operates correctly.)
- 7) The products should be stored in the cool and dark place without direct sunshine or moisture.
- 8) Please contact us for overhaul and repair.

## ● Warranty

- 1) Warranty Period

- The product warranty period is 18 months from shipment from our factory or 12 months from initial use, whichever is earlier.

- 2) Warranty Scope

- If the product is damaged or malfunctions during the warranty period due to faulty design, materials or workmanship, we will replace or repair the defective part at our expense. Defects or failures caused by the following are not covered.

- ① If the stipulated maintenance and inspection are not carried out.
- ② If the product is used while it is not suitable for use based on the operator's judgment, resulting in defect.
- ③ If it is used or operated in an inappropriate way by the operator. (Including damage caused by the misconduct of the third party.)
- ④ If the defect is caused by reasons other than our responsibility.
- ⑤ If repair or modifications are carried out by anyone other than Kosmek, or without our approval and confirmation, it will void warranty.
- ⑥ Other caused by natural disasters or calamities not attributable to our company.
- ⑦ Parts or replacement expenses due to parts consumption and deterioration. (Such as rubber, plastic, seal material and some electric components.)

Damages excluding from direct result of a product defect shall be excluded from the warranty.

# Sales Offices

## Sales Offices across the World

Japan	KOSMEK LTD. HEAD OFFICE	<b>TEL. +81-78-991-5162</b> FAX. +81-78-991-8787 1-5, 2-chome, Murotani, Nishi-ku, Kobe-city, Hyogo, Japan 651-2241
USA	KOSMEK (USA) LTD. Overseas Subsidiary	<b>TEL. +1-630-620-7650</b> FAX. +1-630-620-9015 650 Springer Drive, Lombard, IL 60148 USA
	KOSMEK USA ATLANTA BRANCH OFFICE	<b>TEL. +1-630-620-7650</b> 303 Perimeter Center North, Suite 300, Atlanta, GA 30346 USA
Mexico	KOSMEK USA MEXICO BRANCH OFFICE	<b>TEL. +52-442-851-1377</b> Av. Loma Pinal de Amoles 320-piso PH oficina 504 interior 13, Vista Dorada, 76060 Santiago de Querétaro, Qro. Mexico
Europe	KOSMEK EUROPE GmbH Overseas Subsidiary	<b>TEL. +43-463-287587</b> FAX. +43-463-287587-20 Schleppeplatz 2 9020 Klagenfurt am Wörthersee Austria
China	KOSMEK (CHINA) LTD. Overseas Subsidiary	<b>TEL.+86-21-54253000</b> FAX. +86-21-54253709 Room601, RIVERSIDE PYRAMID No.55, Lane21, Pusan Rd, Pudong Shanghai China
	KOSMEK (CHINA) LTD. Dongguan Office Overseas Subsidiary (Sales Office)	<b>TEL.+86-769-85300880</b> Room 603, Xinchuang Power Building (No. 122-1 West Houjie Avenue), Houjie Town, Dongguan City, Guangdong Province, China
	KOSMEK (CHINA) LTD. Wuhan Office Overseas Subsidiary (Sales Office)	<b>TEL.+86-15802172393</b> Room 309, Chuanggu Technology Building, 266 Taizihu Rd, Zhuankou Subdistrict, Caidian District, Wuhan 430056, Hubei Province, China
India	KOSMEK LTD. - INDIA Branch	<b>TEL. +91-9880561695</b> 4A/Old No:649, Ground Floor, 4th D cross, MM Layout, Kavalbyrasandra, RT Nagar, Bangalore -560032 India
Thailand	KOSMEK Thailand Representative Office Representative Office	<b>TEL. +66(0)2-059-2010</b> No.139, Blue Chips Building, 4th Floor, Room No.422, Soi Sukhumvit 63 (Thong Lor 10), Sukhumvit Road, Khlong Tan Nuea, Wattana, Bangkok 10110, Thailand
Taiwan	FULL LIFE TRADING CO., LTD. Distributor	<b>TEL. +886-2-82261860</b> FAX. +886-2-82261890 16F-4, No.2, Jian Ba Rd., Zhonghe District, New Taipei City Taiwan 23511
Philippines	G.E.T. Inc, Phil. Distributor	<b>TEL.+63-2-310-7286</b> FAX. +63-2-310-7286 Victoria Wave Special Economic Zone Mt. Apo Building, Brgy. 186, North Caloocan City, Metro Manila, Philippines 1427
Indonesia	PT. Yamata Machinery Sales Distributor	<b>TEL. +62-21-29628607</b> FAX. +62-21-29628608 Delta Commercial Park I, Jl. Kenari Raya B-08, Desa Jayamukti Kec. Cikarang Pusat Kab. Bekasi 17530 Indonesia

## Sales Offices in Japan

Head Office Osaka Sales Office Overseas Sales	<b>TEL. 078-991-5162</b> FAX. 078-991-8787 1-5, 2-chome, Murotani, Nishi-ku, Kobe-city, Hyogo, 651-2241, Japan
Tokyo Sales Office	<b>TEL. 048-652-8839</b> FAX. 048-652-8828 81, 4-chome, Onari-cho, Kita-ku, Saitama City, Saitama, 331-0815, Japan
Nagoya Sales Office	<b>TEL. 0566-74-8778</b> FAX. 0566-74-8808 10-1, 2-chome, Misono-cho, Anjo City, Aichi, 446-0076, Japan
Fukuoka Sales Office	<b>TEL. 092-433-0424</b> FAX. 092-433-0426 8-10-101, 1-chome, Kamimuta, Hakata-ku, Fukuoka City, Fukuoka, 812-0006, Japan

# Global Network

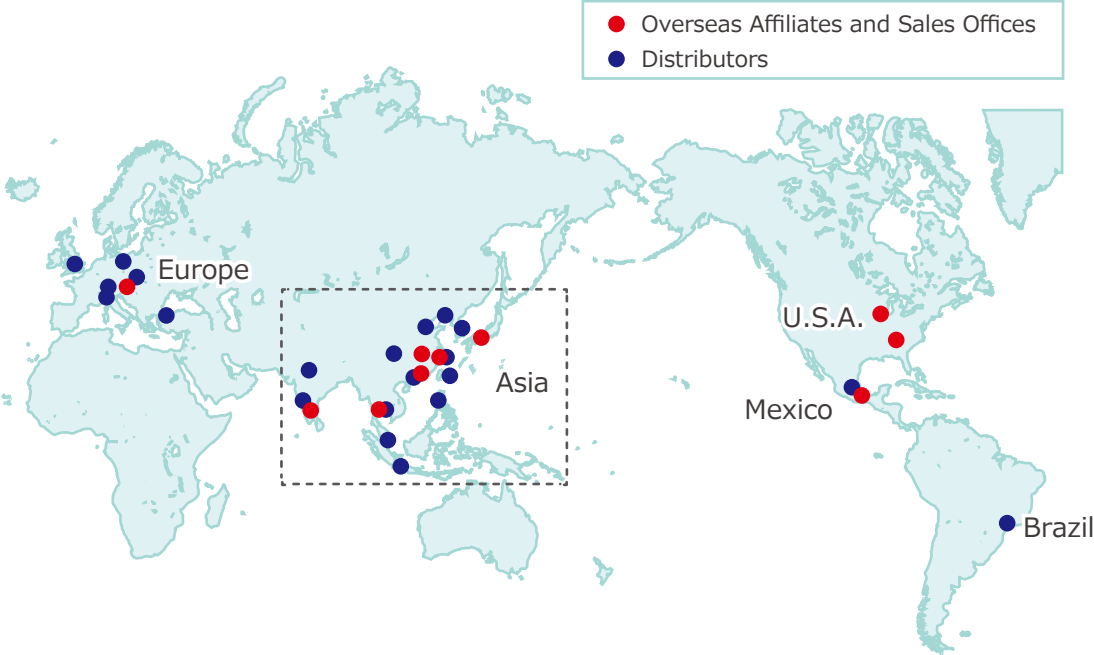

Asia Detailed Map



● FOR FURTHER INFORMATION ON UNLISTED SPECIFICATIONS AND SIZES, PLEASE CALL US.  
● SPECIFICATIONS IN THIS CATALOG ARE SUBJECT TO CHANGE WITHOUT NOTICE.

